

REX-C400 REX-C410 REX-C700 REX-C900 INSTRUCTION MANUAL

IMNZC18-E3

In order to achieve maximum performance and ensure proper operation of your new instrument, carefully read all the instructions in this manual. Please place this manual in a convenient location for easy reference.



WARNING

- An external protection device must be installed if failure of this instrument could result in damage to the instrument, equipment or injury to personnel.
- All wiring must be completed before power is turned on to prevent electric shock, fire or damage to instrument and equipment.
- This instrument must be used in accordance with the specifications to prevent fire or damage to instrument and equipment.
- This instrument is not intended for use in locations subject to flammable or explosive gases.
- Do not touch high-voltage connections such as power supply terminals, etc. to avoid electric shock.
- RKC is not responsible if this instrument is repaired, modified or disassembled by other than factory-approved personnel. Malfunction can occur and warranty is void under these conditions.

CAUTION

- This is a Class A instrument. In a domestic environment, this instrument may cause radio interference, in which case the user may be required to take adequate measures.
- This instrument is protected from electric shock by reinforced insulation. Provide reinforced insulation between the wire for the input signal and the wires for instrument power supply, source of power and loads.
- This instrument is designed for installation in an enclosed instrumentation panel. All high-voltage connections such as power supply terminals must be enclosed in the instrumentation panel to avoid electric shock by operating personnel.
- All precautions described in this manual should be taken to avoid damage to the instrument or equipment.
- All wiring must be in accordance with local codes and regulations.
- To prevent instrument damage or failure, protect the power line and the input/output lines from high currents with a protection device such as fuse, circuit breaker, etc.
- Prevent metal fragments or lead wire scraps from falling inside instrument case to avoid electric shock, fire or malfunction.
- Tighten each terminal screw to the specified torque found in the manual to avoid electric shock, fire or malfunction.
- For proper operation of this instrument, provide adequate ventilation for heat dispensation.
- Do not connect wires to unused terminals as this will interfere with proper operation of the instrument.
- Turn off the power supply before cleaning the instrument.
- Do not use a volatile solvent such as paint thinner to clean the instrument. Deformation or discoloration will occur. Use a soft, dry cloth to remove stains from the instrument.
- To avoid damage to instrument display, do not rub with an abrasive material or push front panel with a hard object.

NOTICE

- This manual assumes that the reader has a fundamental knowledge of the principles of electricity, process control, computer technology and communications.
- The figures, diagrams and numeric values used in this manual are only for purpose of illustration.
- RKC is not responsible for any damage or injury that is caused as a result of using this instrument, instrument failure or indirect damage.
- Periodic maintenance is required for safe and proper operation of this instrument. Some components have a limited service life, or characteristics that change over time.
- Every effort has been made to ensure accuracy of all information contained herein. RKC makes no warranty expressed or implied, with respect to the accuracy of the information. The information in this manual is subject to change without prior notice.
- No portion of this document may be reprinted, modified, copied, transmitted, digitized, stored, processed or retrieved through any mechanical, electronic, optical or other means without prior written approval from RKC.

1. PRODUCT CHECK

Check whether the delivered product is as specified by referring to the following model code list.

REX-C400	
REX-C410	□□□-□□ * □□
REX-C700	① ② ③ ④ ⑤ ⑥ ⑦
REX-C900	

① Control action

F : PID action with autotuning (Reverse action)
D : PID action with autotuning (Direct action)
W : Heat/cool PID action with autotuning (Water cooling) *1
A : Heat/cool PID action with autotuning (Air cooling) *1

② Input type, ③ Range code :

See "8. INPUT RANGE TABLE."

④ First control output [OUT1] (Heat-side)

M: Relay contact T : Triac V : Voltage pulse
8 : Current (4 to 20 mA DC) G : Trigger (for triac driving)

⑤ Second control output [OUT2] (Cool-side)

No symbol: When control action is F or D. M: Relay contact
V : Voltage pulse 8 : Current (4 to 20 mA DC)

⑥ First alarm [ALM1], ⑦ Second alarm [ALM2]

N: No alarm	H: Process high alarm
A: Deviation high alarm	J: Process low alarm
B: Deviation low alarm	K: Process high alarm with hold action
C: Deviation high/low alarm	L: Process low alarm with hold action
D: Band alarm	P: Heater break alarm (CTL-6) *1
E: Deviation high alarm with hold action	S: Heater break alarm (CTL-12) *1
F: Deviation low alarm with hold action	R: Control loop break alarm *2
G: Deviation high/low alarm with hold action	V: SV high alarm
	W: SV low alarm

*1: Heater break alarm can not be specified in case of ALM1. Also, it isn't possible to specify when control output is current output.

*2: As control loop break alarm, only either the first alarm or second alarm is selected.

Confirm that power voltage is also the same as that specified when ordering.

<Accessories>

- Mounting bracket: 2 pieces
- Instruction manual [IMNZC18-E3] (1 copy)

2. MOUNTING



WARNING

● In order to prevent electric shock or instrument failure, do not turn on the power supply until all of the wiring is completed.

■ Cautions for mounting

Avoid the following when selecting the mounting location.

- Ambient temperature of less than 0 °C or more than 50 °C.
- Ambient humidity of less than 45% or more than 85% RH.
- Rapid changes in ambient temperature which may cause condensation.
- Corrosive or inflammable gases.
- Direct vibration or shock to the mainframe.

- Water, oil, chemicals, vapor or steam splashes.
- Excessive dust, salt or iron particles.
- Excessive induction noise, static electricity, magnetic fields or noise.
- Direct air flow from an air conditioner.
- Should be used indoors where the system is not exposed to direct sunlight.
- Heat to be accumulated radiation heat.

■ Dimensions

Unit: mm (inch)

< REX-C400 >

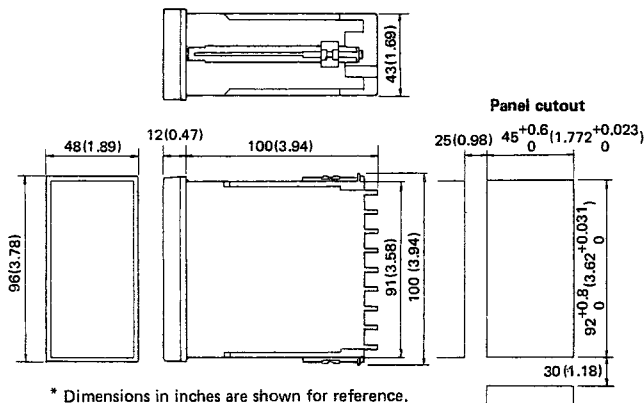

* Dimensions in inches are shown for reference.

< REX-C700 >

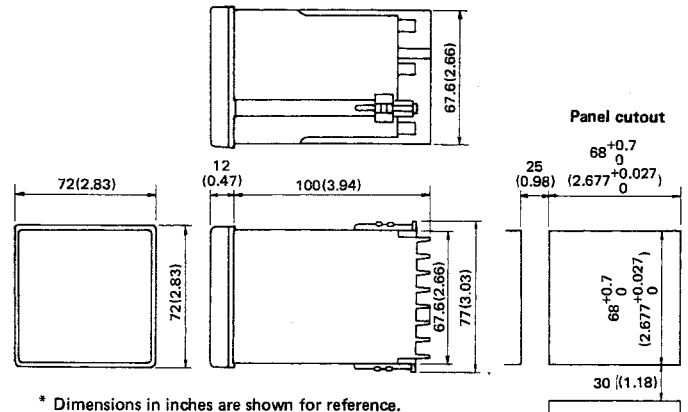

* Dimensions in inches are shown for reference.

< REX-C410 >

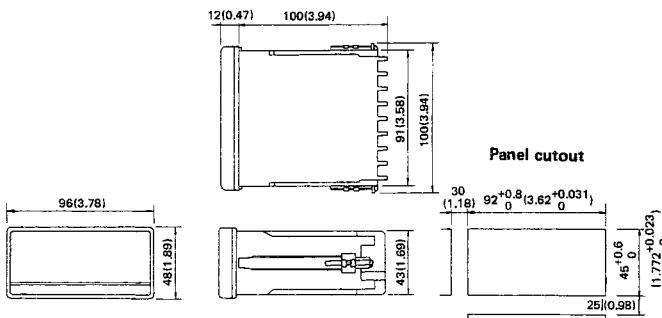

* Dimensions in inches are shown for reference.

< REX-C900 >

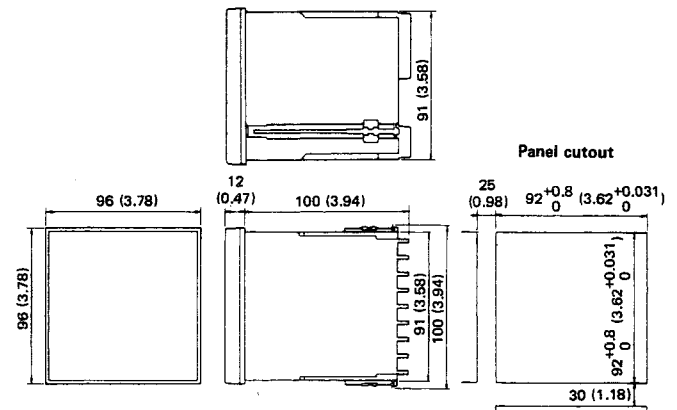

* Dimensions in inches are shown for reference.

■ Mounting procedures

- ① Make a rectangular cutout corresponding to the number of controllers to be mounted on panel by referring to the panel cutout dimensions.
- ② Insert the controllers into the panel from the panel front.
- ③ Insert an upper mounting bracket along the bracket insertion groove from the back, and then engage a projection at the bracket end with a recess at the groove front and also insert metal fitting legs into slots.
- ④ Tighten a bracket setscrew from the rear of the bracket with Phillips screwdriver. Do not overtighten the bracket setscrew.
- ⑤ Set the other mounting bracket in the same way as in ③ and ④.

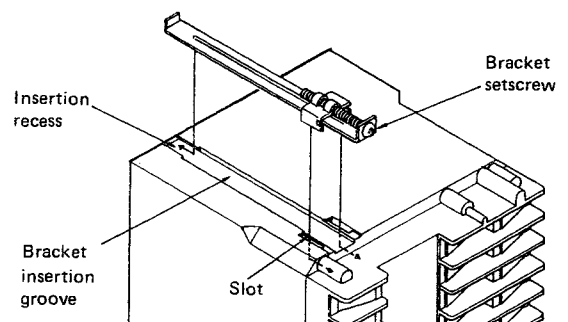

* An example of the REX-C900 is described here, the same mounting example fig. applies to REX-C400, C410, C700.

3. WIRING



WARNING

- In order to prevent electric shock or instrument failure, do not turn on the power supply until all of the wiring is completed.
- If failure or error of this instrument could result in a critical accident of the system, install an external protection circuit to prevent such an accident.
- In order to prevent instrument damage or failure, protect power line and the input/output lines from high currents by using fuses with appropriate ratings.

■ Cautions for wiring ⚠

- (1) For thermocouple input, use the specified compensation wire.
- (2) For RTD input, use leads with low resistance and having no resistance differences among the 3 leads.
- (3) Conduct input signal wiring away from instrument power, electric equipment power and load lines to avoid noise induction.
- (4) Conduct instrument power wiring so as not to be influenced by noise from the electric equipment power. If the instrument may be affected by external noise, a noise filter should be used.
 - Shorten the distance between twisted power supply wire pitches. The shorter the distance between the pitches, the more effective for noise reduction.
 - Install the noise filter on the panel which is always grounded and minimize the wiring distance between the noise filter output side and the instrument power terminals.
 - Do not install fuses and/or switches on the filter output signal since this may lessen filter effect.
- (5) For power supply wires, use twisted wires with low voltage drop.
- (6) About 5 to 6 sec are required as the preparation time for contact output after power on. Use a delay relay when the output line is used for an external interlock circuit.
- (7) This instrument has no power supply switch nor fuses. Therefore, install the fuse close to the instrument and the switch, if required.
 - Recommended fuse rating : Rated voltage ; 250 V Rated current ; 1 A • Fuse type ; Time-lag fuse
- (8) To the instrument with power supply of 24 V, please be sure to supply the power from SELV circuit.
- (9) This instrument is intended to be used under the following environmental conditions. (IEC61010-1)
 - *OVERVOLTAGE CATEGORY II *POLLUTION DEGREE 2

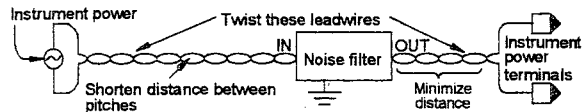

■ Terminal configuration

< REX-C700 >

Output rated

- Relay contact output : 250V AC, 3A (Resistive load)
- Voltage pulse output : 0/12V DC (Load resistance 600Ω or more)
- Current output : 4 to 20mA DC (Load resistance 600Ω or less)
- Trigger output(for triac driving) : Zero-cross method for medium capacity triac driving (100A or less)
Load voltage : 100V AC system, 200V AC system
Load : Resistive load

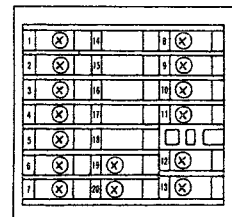

Alarm output rated

Relay contact output : 250V AC, 1A (Resistive load)

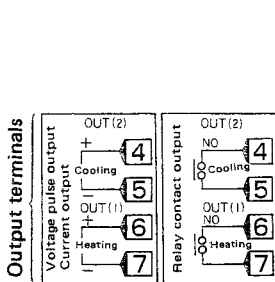
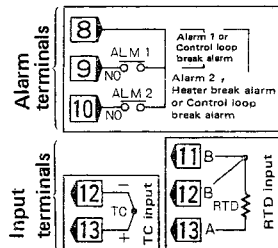

W, A types

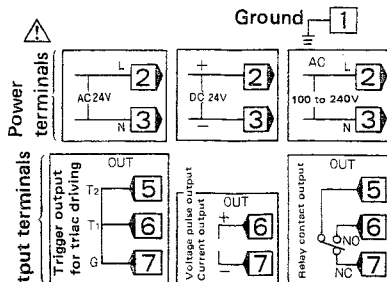

F, D types

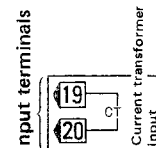

NO: Normally Open

NC: Normally Closed

● Crimp-style terminal lug

Therefore, use the lug suitable for a screw of M3.

- Terminals Nos. 1 to 10 (Power terminals, Alarm terminals and Output terminals)

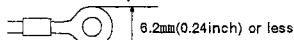

- Terminals Nos. 11 to 13 (Input terminals)

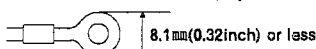

● Recommended tighten torque : 0.4N·m

[Maximum allowance tighten torque : 1.0N·m]

NOTE

Terminals which are not used according to the controller type are all removed.

● Power supply & Power consumption

Power supply	Power consumption
100 to 240 V AC	9 VA max. (at 240 V AC), 6 VA max. (at 100 V AC)
24 V AC	6 VA max. (at 24 V AC)
24 V DC	145 mA max. (at 24 V DC)

● Heater break alarm function

CT input specifications

Measured current : 0 to 30 A (CTL-6-P-N)
0 to 100 A (CTL-12-S56-10L-N)

Input rating :

Maximum current rating : 120 mA
Input impedance : 2.5 Ω

< REX-C400, C410, C900 >

Output rated

-Relay contact output :
250V AC, 3A (Resistive load)

-Voltage pulse output :
0/12V DC (Load resistance 600Ω or more)

-Current output :
4 to 20mA DC (Load resistance 600Ω or less)

-Trigger output(for triac driving) :
Zero-cross method for medium capacity triac driving (100A or less)
Load voltage : 100V AC system, 200V AC system
Load : Resistive load

Alarm output rated

Relay contact output :
250V AC, 1A (Resistive load)

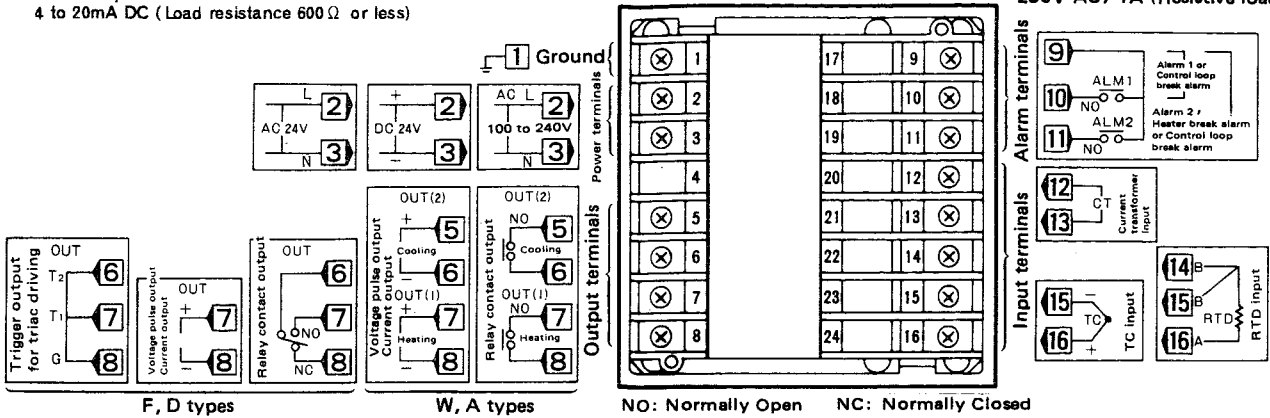

- Crimp-style terminal lug
Therefore, use the lug suitable for a screw of M3.

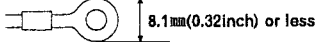

- Recommended tighten torque : 0.4N·m
[Maximum allowance tighten torque : 1.0N·m]

● Power supply & Power consumption

Power supply	Power consumption
100 to 240 V AC	9 VA max. (at 240 V AC), 6 VA max. (at 100 V AC)
24 V AC	6 VA max. (at 24 V AC)
24 V DC	145 mA max. (at 24 V DC)

- Heater break alarm function
CT input specifications
- Measured current:
0 to 30 A (CTL-6-P-N)
0 to 100 A (CTL-12-S56-10L-N)
- Input rating :
Maximum current rating: 120 mA
Input impedance : 2.5 Ω

- NOTES**
1. Terminals which are not used according to the controller type are all removed.
 2. An example of the REX-C900 is described here, the same wiring example fig. applies to REX-C400, C410. (Terminal Nos. 17 to 24 are not provided for REX-C400, C410)

4. NAME OF PARTS

< REX-C400 >

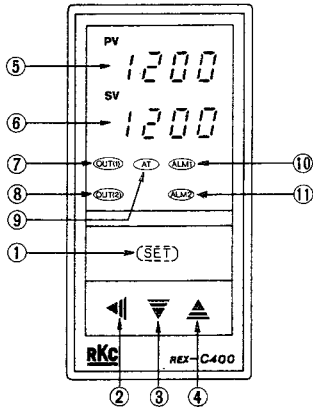

< REX-C700 >

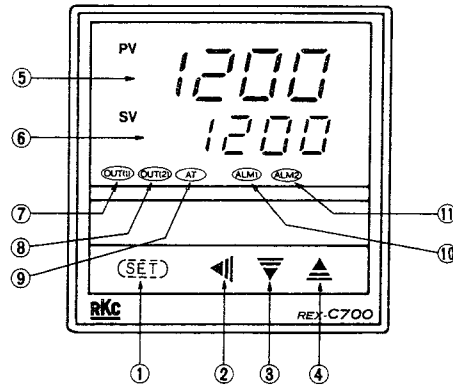

< REX-C410 >

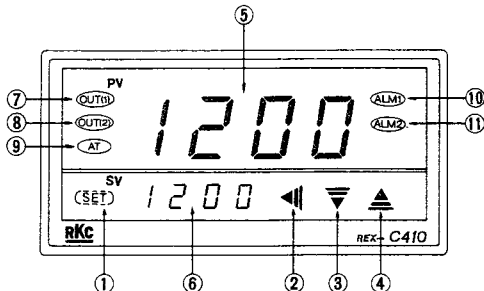

< REX-C900 >

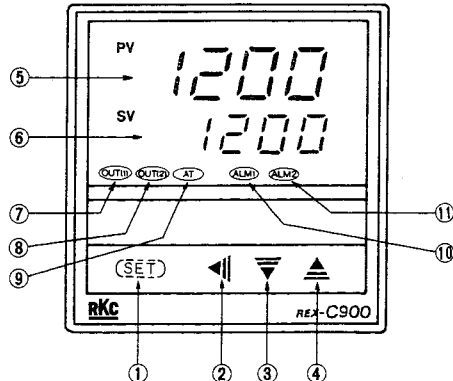

- ① Set (SET) key
- ② Setting digit shift key
- ③ Set value decrement key
- ④ Set value increment key
- ⑤ Measured value (PV) display unit (Green)
- ⑥ Set value (SV) display unit (Orange)
- ⑦ First control output (OUT1) lamp (Green)
- ⑧ Second control output (OUT2) lamp (Yellow)
- ⑨ Autotuning (AT) lamp (Green)
- ⑩ First alarm (ALM1) lamp (Red)
- ⑪ Second alarm (ALM2) lamp (Red)

5. OPERATION

■ Calling-up procedure of each mode

⏮⏭ : Press the (SET) key.

⏮⏭ : Press the (SET) key for more than 5 sec.

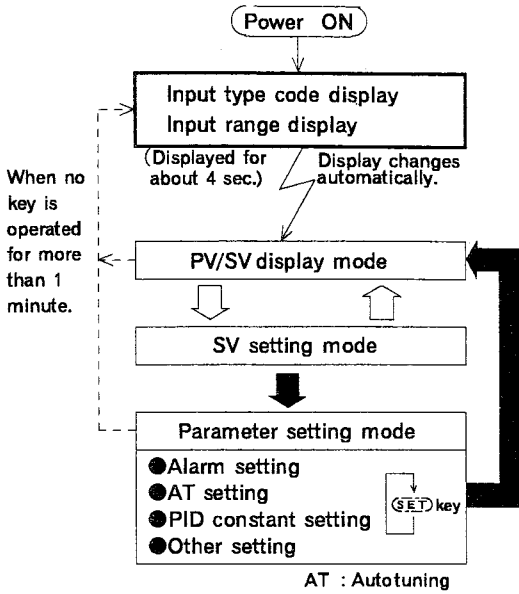

Input type code/input range display

This controller, with the power turned ON, displays automatically the input type code on the measured value (PV) display unit and the input range, on the set value (SV) display unit, respectively.

Example:

For a controller with the K thermocouple input type and input range from 0 to 1372 °C

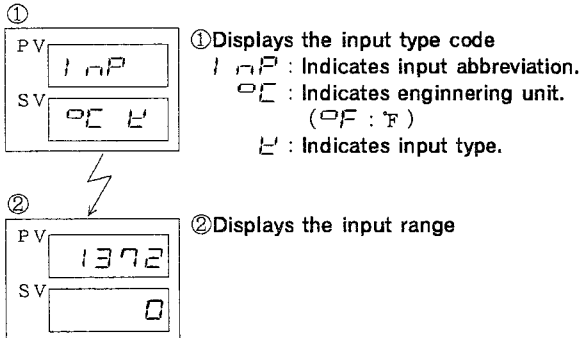

PV/SV display mode

Display measured value(PV) on the measured value(PV) display unit and set value(SV) on the set value(SV) display unit. Usually the the control is set to this mode excepting that the set value(SV) and/or the parameter set value are changed.

SV setting mode

The set value(SV) can be changed.

<Initial value prior to shipment>

Set value(SV) : 0°C [°F] or 0. 0°C [°F]

*Desired value for control.

Parameter setting mode

Parameter setting mode is used to set various parameters and alarms.

<INPUT RANGE TABLE>

Input type Character	Range	Code	Input type Character	Range	Code		
TC	0 to 200°C	01	TC	0 to 800°C	01		
	0 to 400°C	02		E	0 to 1000°C	02	
	0 to 600°C	03		E	0 to 1600°F	A1	
	0 to 800°C	04			0 to 1832°F	A2	
	0 to 1000°C	05		N	0 to 200°C	01	
	0 to 1200°C	06			0 to 300°C	02	
	0 to 1372°C	07			0 to 1000°C	N 04	
	0 to 100°C	K 13			0 to 2300°F	A1	
	0 to 300°C	14		N	0 to 2372°F	A2	
	0 to 450°C	17			T	-199.9 to +400.0°C	01
	0 to 500°C	20		-199.9 to +100.0°C		02	
	0 to 800°F	A1		-100.0 to +200.0°C		03	
	0 to 1600°F	A2		0.0 to 350.0°C		04	
	0 to 2502°F	A3		-199.9 to +752.0°F		T A1	
20 to 70°F	A9	-100.0 to +200.0°F	A2				
TC	0 to 200°C	01	TC	0.0 to 450.0°F		A4	
	0 to 400°C	02		0.0 to 752.0°F		A5	
	0 to 600°C	03		W5Re/W26Re		0 to 2000°C	01
	0 to 800°C	04			0 to 2320°C	W 02	
	0 to 1000°C	05			U	0 to 4000°F	A1
	0 to 1200°C	J 06				PLH	0 to 1300°C
	0 to 450°C	J 10			0 to 1390°C		02
	0 to 800°F	A1		0 to 1200°C	A 03		
	0 to 1600°F	A2		P	0 to 2400°F	A1	
	0 to 2192°F	A3			0 to 2534°F	A2	
	0 to 400°F	A6		U	-199.9 to +600.0°C	01	
	0 to 300°F	A7			-199.9 to +100.0°C	02	
	0 to 1600°C	01			0.0 to 400.0°C	03	
	0 to 1769°C	02			-199.9 to +999.9°F	U A1	
0 to 1350°C	R 04	-100.0 to +200.0°F	A2				
0 to 3200°F	A1	U	0.0 to 999.9°F	A3			
0 to 3216°F	A2		L	0 to 400°C	01		
0 to 1600°C	01	0 to 800°C		02			
0 to 1769°C	S 02	0 to 800°F		L A1			
0 to 3200°F	A1	0 to 1600°F		A2			
0 to 3216°F	A2	B	/	/			
400 to 1800°C	01						
0 to 1820°C	02						
800 to 3200°F	B A1	b	/	/			
0 to 3308°F	A2						

*Accuracy in the range of 0 to 399°C (0 to 799°F): Not guaranteed.

Input type Character	Range	Code	Input type Character	Range	Code		
RTD	-199.9 to +649.0°C	01	RTD	-199.9 to +649.0°C	01		
	-199.9 to +200.0°C	02		JPt100	-199.9 to +200.0°C	02	
	-100.0 to +50.0°C	03			-100.0 to +50.0°C	03	
	-100.0 to +100.0°C	04			-100.0 to +100.0°C	04	
	-100.0 to +200.0°C	05			P	-100.0 to +200.0°C	05
	0.0 to 50.0°C	06				0.0 to 50.0°C	06
	0.0 to 100.0°C	07			D	0.0 to 100.0°C	07
	0.0 to 200.0°C	08				0.0 to 200.0°C	08
	0.0 to 300.0°C	09			JP	0.0 to 300.0°C	09
	0.0 to 500.0°C	10				0.0 to 500.0°C	10
	-199.9 to +999.9°F	A1			/	/	/
	-199.9 to +400.0°F	A2					
	-199.9 to +200.0°F	A3					
	-100.0 to +100.0°F	A4					
-100.0 to +300.0°F	A5						
0.0 to 100.0°F	A6						
0.0 to 200.0°F	A7						
0.0 to 400.0°F	A8						
0.0 to 500.0°F	A9						

Parameter types

The following parameter symbols are displayed one by one every time the (SET) key is pressed.

However, some parameter symbols may not be displayed depending on the specification.

Symbol	Name	Setting range	Description	Initial value prior to shipment
CT	Current transformer input	Setting is not possible. Set heater break alarm value by referring to this value.	Display input value from the current transformer.	
AL1	First alarm	Deviation alarm+Process alarm: -1999 to +9999°C[°F] or -199.9 to +999.9°C[°F]	Set alarm set value of first alarm.	50 or 50.0
AL2	Second alarm	Differential gap: 2 or 2.0°C[°F]	Set alarm set value of second alarm.	
HbA	Heater break alarm	0.0 to 100.0A	Alarm value is set by referring to input value from the current transformer (CT).	0.0
LbA	Control loop break alarm	0.1 to 200.0 min.	Set control loop break alarm set-value. Cannot be set to "0.0".	8.0
Lbd	LBA deadband	0 to 9999°C[°F] Differential gap: 0.8°C[°F]	Set the area of not outputting LBA. No LBA deadband functions with "0" set.	0
ATU	Autotuning	0000: Autotuning end or stop 0001: Autotuning start	Turns the autotuning ON/OFF.	0000
P	(Heat side) Proportional band	1 to span or 0.1 to span	Set heat side proportional band. ON/OFF action with P set to "0" or "0.0".	30 or 30.0
I	Integral time	1 to 3600 sec.	Eliminates offset occurring control is performed. I action turns OFF with I set to "0".	240
d	Derivative time	1 to 3600 sec.	Prevents ripples by predicting output change thereby improving control stability. D action turns OFF with D set to "0".	60
Ar	Anti-reset windup	1 to 100% of proportional band (heat side).	Prevents overshoot and/or undershoot caused by integral action. I action turns OFF with this action set to "0".	100
T	(Heat side) Proportional cycle	1 to 100 sec.	Set control output cycle (on the heat side).	Relay contact output: 20 Voltage pulse output, Trigger output for triac driving: 2
Pc	(Cool side) Proportional band	1 to 1000% of proportional band (heat side).	Set when proportional control is performed on the cool side.	100
db	Deadband	-10 to +10°C[°F] or -10.0 to +10.0°C[°F]	Set control action deadband between heating and cool side proportional bands.	0 or 0.0
t	(Cool side) Proportional cycle	1 to 100 sec.	Set control output cycle (on the cool side).	Relay contact output: 20 Voltage pulse output: 2
LCK	Set data lock	0100: No set data locked (All parameters changeable) 0101: Set data locked (All parameters not changeable) 0110: Only the set-value (SV) is changeable with the set data locked	Performs set data change enable/disable.	0100

*The second alarm (or first alarm), heater break alarm, control loop break alarm parameter symbols are not simultaneously displayed.

*Heater break alarm is not available on a current output.

*No control loop break alarm can be used at heat/cool PID control action.

■ Parameter setting procedure

Setting set value (SV)

Following is an example of set value(SV) to 200 °C .

- ① Set to the SV setting mode ② Shift of the digit brightly lit ③ Numeric-value change ④ Set value entry

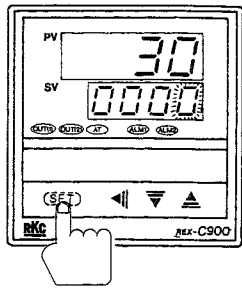

Press the (SET) key enter the SV setting mode. The digit which light brightly is settable.

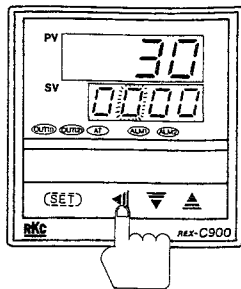

Press the ◀ key to shift the digit which lights brightly up to the hundreds digit.

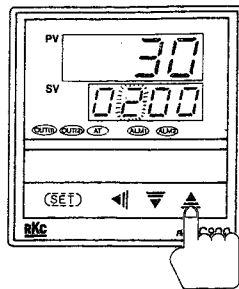

Press the ▲ key to set "2". Pressing the ▲ key increments numerals, and pressing the ▼ key decrements numerals.

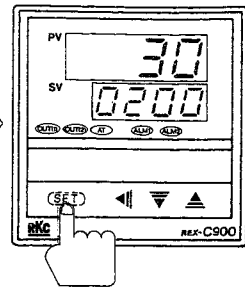

After finishing the setting, press the (SET) key. All of the set value digits light brightly and as a result the controller returns to the PV /SV display mode.

Set value increase or decrease

Example: When a temperature of 199 °C is changed to 200 °C .

Press the ◀ key to shift the digit brightly lit to the least significant digit. Press the ▲ key to change "9" to "0", thereby obtaining 200 °C . The same applies to set value decrease.

Minus (-) value setting

Example: For changing 200 to -100.

Press the ◀ key to shift the digit brightly lit to the hundreds digit. Press the ▼ key to decrement figures in order of 1 → 0 → -1.

Setting parameters other than set value

In the PV/SV display mode

In the parameter setting mode

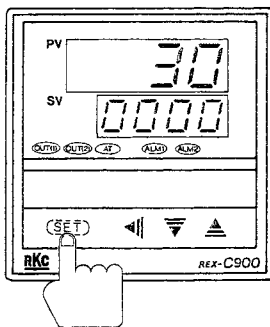

For more than 5 sec.

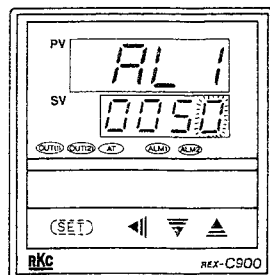

Press the (SET) key for more than 5 sec. to set controller to the parameter setting mode.

Press the (SET) key by the required number of times until the parameter symbol to be set is displayed.

The setting procedures are the same as those of example ② to ④ in the above "Setting set value(SV)" (Pressing the (SET) key after the setting is finished in the parameters).

When no parameter setting is required, return the controller to the PV/SV display mode.

⚠ Key operational cautions

- For this controller, the value whose setting was changed is not registered. It is registered for the first time it is shifted to the next parameter by pressing the (SET) key.
- When the controller is not set to the SV setting mode (the set value (SV) does not light brightly or dimly even with the (SET) key pressed) or each value does not light brightly or dimly even with the controller moved to the parameter setting mode, set data lock is activated. In this case, change the "LCK" parameter set value to "0100".
- This controller returns to the PV/SV display mode status if key operation is not performed for more than 1 minute.

- Pay attention to the following when the parameters described below are set.

Autotuning (AT)

- Prior to starting the autotuning function, end all the parameter settings other than PID and control loop break alarm (LBA).

Heater break alarm (HBA)

- Set HBA set value to a value about 85% current transformer input value. However, when power supply variations are large, set the alarm to a slightly smaller value. In addition, when two or more heaters are connected in parallel, set the alarm to a slightly larger value so that it is activated even with only one heater is broken (However, within the value of a current transformer input value.)
- When the HBA set value is set to "0.0" or the current transformer is not connected, the HBA is turned ON.

Control loop break alarm (LBA)

- Usually set the set value of the LBA to a value twice the integral time (I).

Set data locking procedure

This controller is provided with a set data locking function which disables each set value change by the front key and also the autotuning function. Use this function for malfunction prevention at the end of each setting.

- Press the $\overline{\text{SET}}$ key by the required number of times to show "LCK" on the measured value(PV) display unit.
- Press the \leftarrow , \triangle and ∇ keys to set the number in the table. Thus the set data lock state can be selected.

0100	No set data locked (All parameters changeable)
0101	Set data locked (All parameters not changeable)
0110	Only the SV is changeable with the set data locked

NOTES

1. Do not change the upper 2 digits "01" of the set value, as it may cause malfunction.
2. Checking each set value is possible during data lock.

Cautions for operation

- If any problems arise due to hunting exists in the control system, do not use the autotuning function. In this case, set each value to match the controlled object.
- Connect the input signal wiring, and then turn ON the power. If the input signal wiring opens, the controller judges that input is disconnected to cause the upscale of measured value display (For thermocouple input, downscale is also available as option).

- No influence is exerted upon the controller for power failure of 20ms or less.

For power failure of 20ms or more, the controller performs the same operation as that at the time of power ON after power recovery (This applies only when alarm action is turned OFF).

- When the set value (SV) is changed during progress in the autotuning function, suspend the autotuning to perform PID control using the values before autotuning start.
- When the autotuning function is suspended halfway, no values of PID and control loop break alarm are changed. (The value before autotuning function start is maintained.)

6. DISPLAY AT ERROR OCCURRENCE

Error display

ERR	RAM failure (Incorrect set data write, etc.)	Please contact us or your nearest RKC agent.
-----	--	--

Overscale, Underscale

Measured value(PV) (Flashing)	Measured value exceeds the input range.	WARNING In order to prevent electric shock, prior to replacing the sensor, always turn OFF the power.
0000 (Flashing)	Overscale (Measured value exceeds the high input display range limit.)	
UUUU (Flashing)	Underscale (Measured value below the low input display range limit.)	Sensor or input lead check

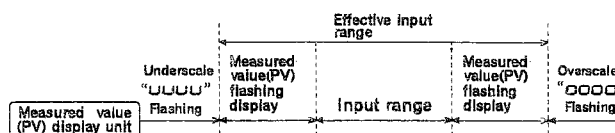

RKC. RKC INSTRUMENT INC.

IMNZC18-E3

HEADQUARTERS : 16-6, KUGAHARA 5 CHOME OHTA-KU TOKYO 146-8515 JAPAN
 PHONE: 03-3751-9799 (+81 3 3751 9799)
 FAX: 03-3751-8585 (+81 3 3751 8585)
 E-mail: info@rkcinst.co.jp